

USER MANUAL

Body worn camera

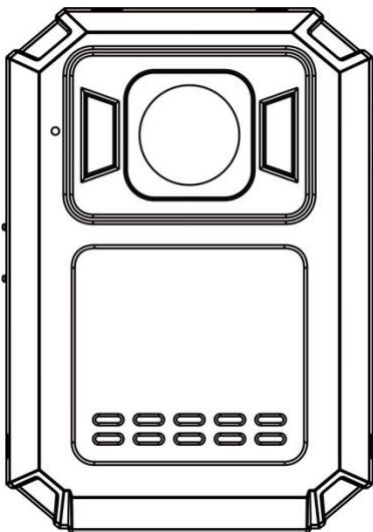

About this Guide

The content in this document is for information purpose and is subject to change without prior notice. We have made every effort to ensure that this User Guide is accurate and complete.

However, no liability is assumed for any errors or omissions that may have occurred.

The manufacturer reserves the right to change the technical specification and accessories without prior notice.

Caution

Do not expose battery being placed in high temperature environment. If battery leaks or bulges, stop to use.

Risk of explosion if battery is placed by an incorrect type.

Dispose of used batteries according to the instructions.

Never replace the battery on your own. Doing so may cause the damage or explosion. Please have the dealer do it for you.

Do not put the LCD display or lens under the sunshine.

Note

A specific emission frequency may influence the image quality.

Please try a few times of video-taking test before you formally use this product in order to be familiar with this product.

Always full charge the battery before use.

Never dismantle, crush, or pierce the product, or allow the product to short-circuit. Please persuade for professional assistance if the product doesn't work properly.

Before you start using this product, it is assumed that you agree to the above statement.

TABLE OF CONTENTS

About this Guide

Caution

Note

Introduction

- 1. Introduction**
- 2. Box Contents**
- 3. Product Overview**
- 4. Main Menu Optional Detail**
- 5. Operation**
- 6. Camera setting through Camera Manager**

This camera is new generation video recorder of High Efficiency video coding (HEVC, H.265) and low power consumption. If you record videos by using H.265 coding format, it is suggested to download Media Player Codec Pack (check below link) to assist to play back H.265 videos on windows Media Player.

<https://www.mediaplayercodecpack.com/>

1. Introduction

Thank you for purchasing this product. This camera is specially designed for video recording, audio recording and photo shooting. Please read the user manual before you start to use it.

Important information: before you start to use this device, please connect it to computer through auxiliary USB cable, then camera will require password in the LCD screen. Please **press OK button for six times** to get access to camera storage, then copy **BodyCam PC software** from camera folder to your windows system computer for camera setting purpose in the future. Without the software, you can also change camera setting on camera menu (Page 8). **BodyCam PC software** will be deleted if you format the camera storage. Please contact vendor if it is lost.

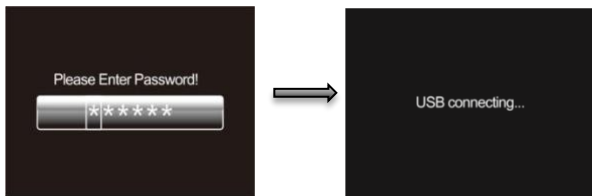

2. Box contents

- Body Camera
- Charging Dock
- USB Cable
- Wall Charger
- Rotatable Epaulette Clip
- Rotatable Crocodile Clip
- User Manual

3. Product Overview

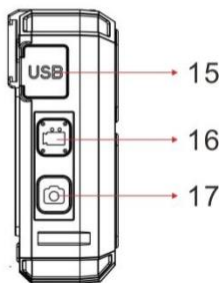
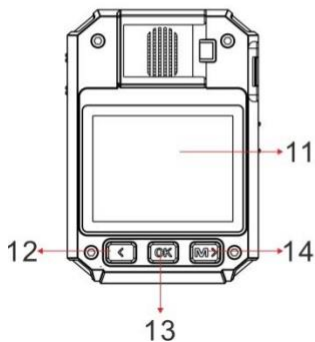
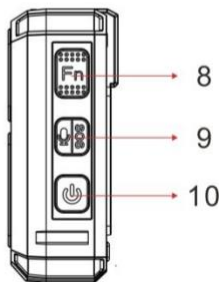
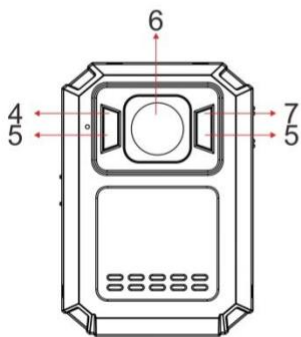
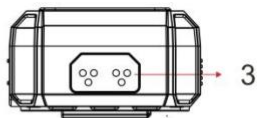
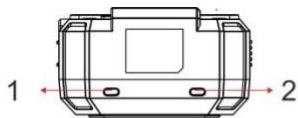

Item	Description
1. Status Indicator LED	Still Green: camera is in standby mode (Power on but not recording) Still Red: camera is on pre-recording mode Flashing Red: camera is recording video Flashing Yellow: camera is recording audio only
2. Charging Indicator LED	Red: Charging Status Green: Camera is fully charged
3. Pogo Pin	Connection port to charging dock
4. Light Sensor	Detect changes of light and turn on/off IR for low-light recording automatically
5. Infrared LED	Providing infrared light compensation in low light conditions, to help camera record good quality video with clear face view up to 10 meters
6. Lens	Capture high resolution images/videos
7. White Light	Hold OK button to turn on/off white light
8. Fn Button	a) Press to mark video/audio as importance when on video/audio recording. b) Press to switch between video, photo and audio when playing back files.
9. Audio / SOS Button	a) Press to start/stop audio recording b) Hold to turn on/off SOS mode (flashing lights)
10. Power Button	a) Hold 3 seconds to power on/off camera b) In power-on mode, short press to turn on/off LCD . c) Short press to exit to previous interface when navigating setting or playing back files

11. LCD Screen	View camera status and playback recorded files
12.Scroll Up Button	<ul style="list-style-type: none"> a) Hold to switch 720P and 1080P resolution b) In Menu or Playback mode, short press to scroll up to previous page or file c) In standby or video recording mode, hold to zoom out d) In playback mode, press to rewind video
13. OK Button/ White Light Button	<ul style="list-style-type: none"> a) In menu set-up, short press to make a selection b) In standby mode, press to review files c) In playback mode, press to pause/resume video or audio playback d) hold to turn on/off white lights.
14. Menu & Scroll Down Button	<ul style="list-style-type: none"> a) In standby mode, short press to enter menu set-up b) In Menu or Playback mode, short press to scroll down next page or file c) In standby or video recording mode, hold to zoom in d) In playback mode, press to fast forward video
15.USB Port	USB port is for power charging or data transmission;
16.Video Recording Button	<ul style="list-style-type: none"> a) In power-on mode, short press to start/stop recording b) In power-off mode, hold for 3 seconds to power on camera and execute video recording function.
17.Snapshot Button / Infrared Light Button	<ul style="list-style-type: none"> a) Press to take photo in standby mode or in video recording mode b) Hold to turn on/off infrared lights.

LCD Interface:

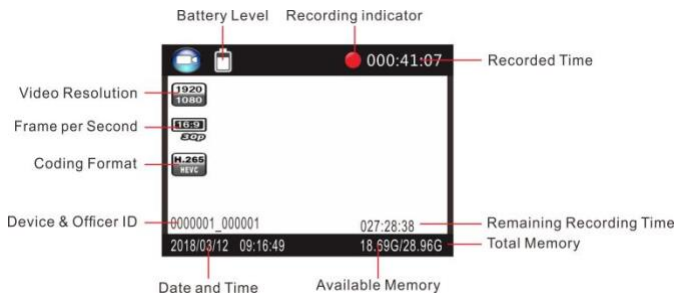

4. Main Menu Optional Detail

To enter the setting menu:

1. Press Menu button  and then enter the password.
2. Enter the password by the following commands:
 - Press Scroll Up button to change the character to the previous letter or number.
 - Press Menu button to change the character to the next letter or number.
 - Press OK button to confirm and move to the next character

PS: The default password is 000000.

3. After selecting the last character, press OK button to enter the setting menu.

To navigate the settings menu:

- Press Scroll Down button to select next setting or option.
- Press Scroll Up button to select the previous setting or option.
- Press OK button to move to confirm your selection or enter the sub-menu.
- Press Power button to return to the previous menu.

Following is a list of the available settings and options.

Setting	Description	Options
Video Resolution	The video resolution	2688x1512 30P 2560x1440 30P 2304x1296 30P 1920x1080 30P 1280x720 30P 864x480 30P
Coding Format	The coding format of video files	H.264, H.265
Quality	The quality of the video.	S.Fine, Fine, Normal

Pre-record	When on, a certain time (depend on video resolution) will be combined into the recorded video before record button is pressed to start recording; When off, video start until the Record button is pressed to start recording.	OFF, ON
Post Record	The amount of the time the camera waits to stop recording video after you press the Record button.	OFF, 5 sec, 1 Min, 10 Mins, 20 Mins, 35 Mins
Dewarp	When on, video distortion correction will be corrected, with more power consumption.	OFF, ON
EIS	When on, electronic image stabilization is activated to avoid shaky video.	OFF, ON
CarDV Mode	When on, camera will power up automatically and start video recording when it is charged. Camera will power off as it normally does when it is disconnected from the power source.	OFF, ON
Loop Recording	When on, camera will overwrite the oldest video file with the most current video file once its memory is full.	OFF, ON
Split Time	While recording video, the camera will automatically split its recording into files of this length.	1 Min, 3Mins, 5 Mins, 10 Mins, 15 Mins, 30 Mins, 45Mins
Photo Resolution	The photo resolution	40M (8448x4752 16:9) 30M (7296x4104 16:9) 25M (6656x3744 16:9) 20M (5984x3366 16:9) 12M (4608x2592 16:9) 5M (3008x1692 16:9)
Burst	The number of images captured in a row when you take a photo.	OFF, 2, 3, 5, 7, 10, 15, 20
Self Timer	The time camera waits until taking a photo after you press Snapshot button.	OFF, 5 seconds, 10 seconds, 20 seconds, 30seconds, 1 Min

Slideshow	When on, viewing photo file will start a slideshow where each photo will be shown for around 5 seconds.	OFF, ON
Infrared	When set to manual, you will need to hold Snapshot button to turn IR LEDs on/off. When set to Auto, these lights will activate automatically based on the light sensor's reading.	Manual, Auto
Motion Detect	When turn on motion detect and then press recording button, camera will start recording when front movement is detected by the lens.	OFF, ON
Record Warning	When on, you will hear a voice confirmation when you start/stop recording. When off, voice confirmation is disabled.	OFF, ON
Video Mute	When on, there is no sound in the video. When off, there is sound in the video	OFF, ON
Global Positioning	When GPS is on, position of video will be recorded and can be reviewed by GPS player.	OFF, ON
WiFi	WiFi mode	OFF,ON(STA),ON(AP)
G-sensor / G-sensor sensitivity	When G-sensor is on, camera will detect attack from external force and trigger video recording.	OFF, High, Middle, Low
Time Zone	Adopt local time in real time zone	-12 to +12 Default 0
Language	The language of the text in camera interface	English , 简体中文, Русский, Polski, 한국, French, 日本語, Portuguese, Español, Türk,український
Screen Saver	The amount of the time the camera can be idle before deactivating the display to conserve power.	OFF, 30 seconds, 1 Min, 3 Mins, 5 Mins
LCD Brightness	Screen lighting to view	Low, Medium, High

Auto Power off	The amount of the time the camera can be idle before powering off.	OFF, 30 seconds, 1 Min, 3 Mins, 5 Mins
Led Light	When on, indicator LED will tell the status of the camera; When off, camera is entering covert mode	OFF, ON
White Led	White Led light to offer light source	OFF, ON
Key Tone	When on, camera will play a tone each time you press a button. When off, tone is disabled.	OFF, ON
Motor	Switch of vibration indication	OFF, ON
Volume	The volume of camera speaker. This affects the loudness of video playback, audio playback, the key tone, record warning, and any other sounds played by camera. This doesn't affect the volume of the recorded video or audio files themselves.	0-12 Default 12
Time Setup	Adjust time to real location	yyyy/mm/dd hh/mm
ID Setting	User can set Device SN and Person SN	Alphanumeric characters
Password	If password is on, user needs to enter password to get access to setting and connection to PC	OFF, ON
Change Password	Password can be set or changed	Alphanumeric characters
Default Setting	Use this to return camera to its original settings. This does not erase the memory	O (Yes), X (No)
FW Name	Firmware version	



5. Operation

5.1 Power on/off

Hold Power button  for 3 seconds to start up and enter standby mode; In any mode with holding Power button for 3 seconds, camera will shut down.

PS: in standby / video recording / audio recording mode, short press power button , screen saver can be on/off.

5.2 Audio recording



In standby mode, press audio Recording Button  for audio recording. Camera will beep, and vibrate once and LED indicator on the top turns yellow and flashes. Press again audio Recording Button  to stop audio recording (camera vibrates twice) and save the file.

In audio recording mode, short press Fn button  to remark the file as an important file, the yellow star icon will appear at the right side on screen.

5.3 Photo shooting

In standby mode, press photo button  to take photos.

5.4 Video recording

In standby mode, press video Recording Button  to start video recording. Camera will beep, and vibrate once and LED indicator on the top turns red and flashes. Press again video Recording Button  to stop video recording (camera vibrates twice) and save the file.

In video recording mode, short press Fn button  to remark the file as an important file, the yellow star icon will appear at the right side on screen.

5.5 One-button video recording

In power-off mode, hold video Recording Button  for three seconds for powering on the camera and start video recording immediately.

5.6 PIV (picture in video)



In video recording mode, press photo button  to capture photo.

5.7 Zoom

In standby or video recording mode, hold Scroll Up button and scroll down button to zoom out and in the image.

5.8 IR night vision

Under dark circumstances, infrared LED will help to record clear image or video.

In standby mode, PRESS Menu button  to navigate. Find option **【Infrared】**, PRESS OK button  to enter sub-menu: Manual & Auto, press OK button  to select.

1) Auto infrared mode:

In low light situations (1 Lux), 4 IR LEDs will be turned on automatically, camera switches on infrared filter lens, video image turn black and white. Otherwise, when circumstance brightness grew up, IR LED turns off, and image becomes colorful again.



2) Manual infrared mode:

When night vision is needed, hold infrared light button  to switch to Infrared mode, IR LEDs will be turned on, black and white image. Hold this button again to turn off IR LEDs, image becomes colorful.

5.9 White LED

In standby or video recording mode, hold OK button  to turn on/off white LED.

5.10 Playback

In standby mode, press OK button to enter playback mode. There are Video, Photo, and Audio options. Press Fn button  to select, and press OK button  to confirm the selection.

1) In video file playback mode, PRESS OK button  to pause/resume



playback; PRESS scroll-Up button to rewind, PRESS Scroll-down button to fast forward, then PRESS OK button  to play normally. You can fast forward or rewind 2x, 4x, 8x, 16x, 32x, 64x.

2) In photo file playback mode, hold scroll-Up button and Scroll-down button to zoom out and in the image. Adjustable is X1.0~X10.0. In the zoom in and out image, short press scroll-Up button and Scroll-down button to move the image to right or left side.

5.11 Reset



In any case the camera is frozen, use a pin to reset and restart the camera. Reset button is inside USB port.

5.12 Device ID/ User ID

In standby mode, PRESS Menu button  to enter settings. Find [ID setting], PRESS OK button  to select, then the Device & Person SN interface will show up, 5 characters for device ID and 6 characters for person ID.

PRESS scroll-Up button or Scroll-down button to choose a character, then PRESS OK  button to select.

5.13 Time Setting

In standby mode, PRESS Menu button  to enter settings. Find Time bar, for example, 2008/02/02 07:40. PRESS OK button  and enter the password, then users can change the date and time.

Press scroll-Up button or Scroll-down button to choose a character, then PRESS OK button  to select.

5.14 Video/Photo/Audio files can only be deleted on PC/laptop.

After being connected to PC, password interface shows up, please enter the password (default password is 000000) Press the (ok) button 6 times, the camera will be recognized by the computer as Extra drive. User can go to camera folder and delete those files not needed.

5.15 Charging

When camera battery is low, the battery icon will flash in the display, and you will hear a alert tone. When this happens, charge the camera.

While camera is charging, indicator light turns red and will turn green after camera is fully charged. It will take approximately 4 hours to fully charge the camera.

Charging methods:

1). Attach the device to the charging dock. Use the original USB cable to connect the charging dock to the following:

- The original wall charger (connect to a power outlet)

2). Use the original USB cable to connect the device's USB port to the following:

- The original wall charger (connect to a power outlet)

5.16 WiFi

AP mode - used for single device real time video review and controlling.

Android phone: Scan below QR code

Apple iPhone : Search "Eyescam pro" in App Store



Get the WIFI APP (AP mode)

iOS system phone & tablet:
Search "Eyescam pro" in App Store

Android system phone & tablet:
Scan below QR code

Eyescam pro

Android

The banner features a blue background with a green and teal wave pattern at the bottom. On the left is a white rounded square containing a blue stylized eye icon. To the right of the icon is the text 'Eyescam pro'. Further right is a QR code and an Android logo icon. At the top right, there is a white rounded rectangle with the text 'Get the WIFI APP (AP mode)'. Below this, there are two paragraphs of text: 'iOS system phone & tablet: Search "Eyescam pro" in App Store' and 'Android system phone & tablet: Scan below QR code'.

Go to camera menu and Turn on "WiFi". You will see GREEN WiFi icon on top of screen.



Go to phone/tablet WiFi setting. Find out your body camera's WiFi SSID (H22_WIFI_AP as default) and select, then input WiFi password (12345678 as default) and connect.

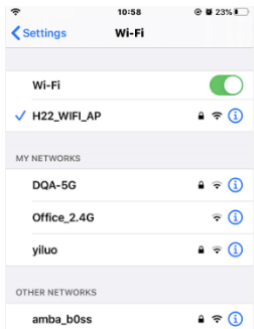

Open Eyescam Pro and tap “connecting device” to enter camera interface.

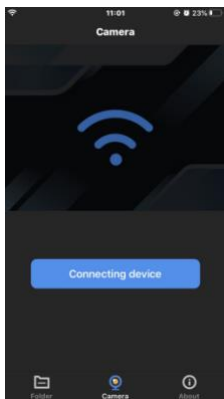

Tap resolution window to change video resolution.

Tap setting icon to enter simple setting menu.

Tap RED button to start/stop video recording.

Tap PHOTO button to make a snapshot.

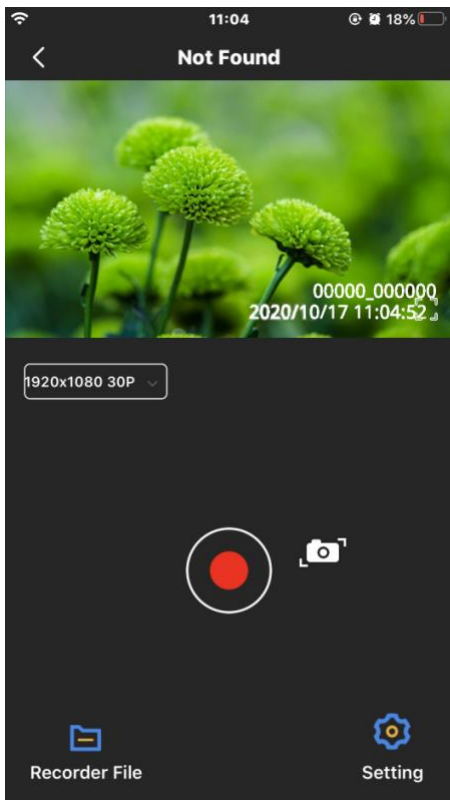



Tap “Recorder File” to view or delete the video and photo files.

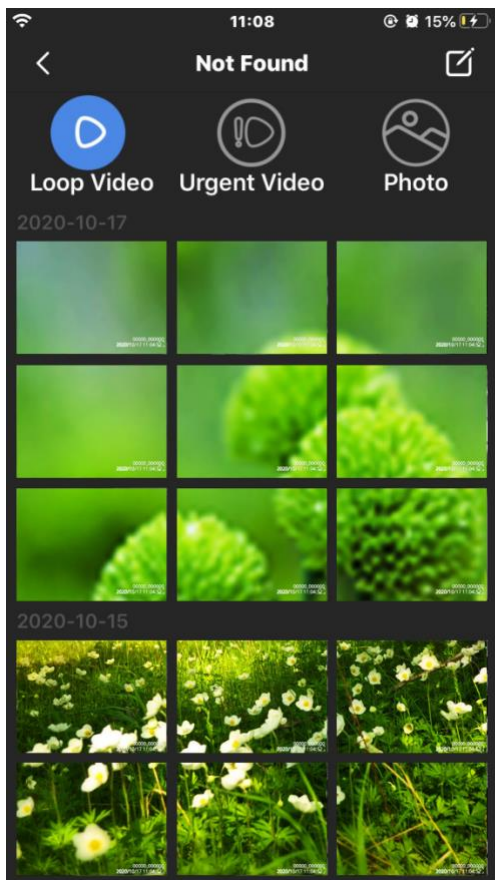

STA mode - used to view and control multiple cameras inside internal network.

Operation is as below:

1, Set “WiFi” to “ON (STA)” on menu.

2, Connect camera to Camera Manager program and set WiFi parameter to same as WiFi router (enter WiFi router info and then click “Set”).

The screenshot shows a 'Network' configuration window with three main sections: 'WiFi Information', '4G Information', and 'Server Information'. The 'WiFi Information' section is highlighted with a red border and contains two input fields: 'SSID: H22_WIFI_AP' and 'Password: 12345678'. The '4G Information' section has four input fields: 'APN Addr:', '4G PIN:', 'APN User:', and 'Password:'. The 'Server Information' section has two input fields: 'IP :' and 'Port :'. At the bottom of the window are two buttons: 'Get' and 'Set'.

3, Go to WiFi router setting to check the body camera IP address distributed by router. (If needed, please check with router vendor on how IP address is distributed).

4, Open VLC player and click “Ctrl+N”, then enter `rtsp://IP Address/live` or `rtsp://192.168.1.5/live`. You can view real time stream from camera.

6. Camera setting through Camera Manager

The device setting can be changed in the menu or via **Camera Manager** (Please find it in **BodyCam PC Software** file).

Please check page 3 to get access to it.

Please refer to the steps below when do the device setting via Camera Manager.

A. Copy BodyCam PC Software file on windows system computer and find Camera Manager.

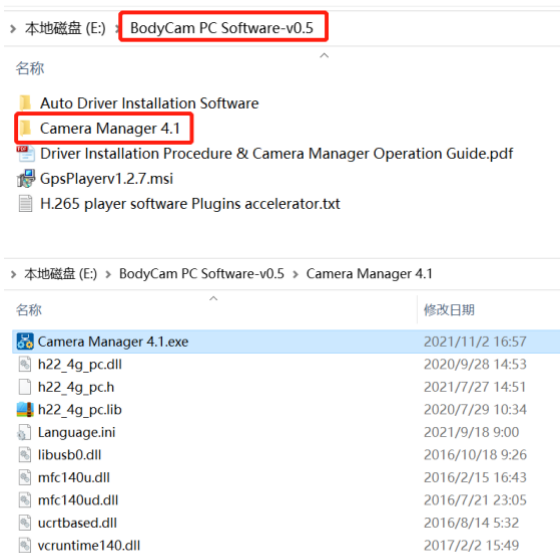

B. Choose “Password On” in the menu of the device.

C. Install the driver (Read the instruction in BodyCam PC Software file to install it).

D. Connect the device to PC.

E. Open Camera Manager and enter password 000000, connect and login.



The screenshot shows a web interface titled "Body Worn Camera". It contains three input fields: "User Type" with a dropdown menu set to "Administrator", "Password" with an empty text box, and "Language" with a dropdown menu set to "English". Below these fields are two buttons: "Connect" and "Login".

F. Click "Get" to show up the device's original settings. Choose the target setting and click "Set" to change the setting.

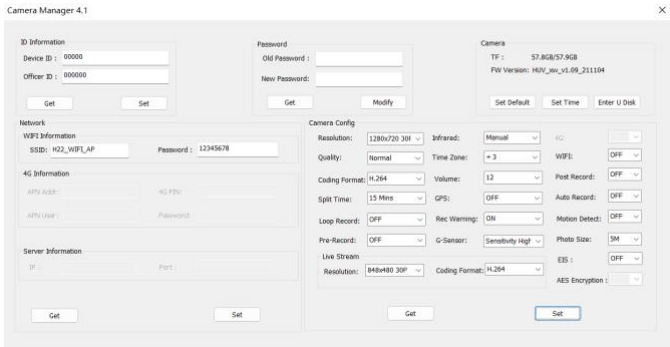

The screenshot shows the "Camera Manager 4.1" application window. It is divided into several sections for configuring the device:

- ID Information:** Fields for Device ID (00000) and Officer ID (000000) with "Get" and "Set" buttons.
- Password:** Fields for Old Password and New Password with "Get" and "Modify" buttons.
- Camera:** Fields for TF (57.8GB/57.9GB) and FW Version (H2V_sw_v1.09_211104) with "Set Default", "Set Time", and "Enter U Disk" buttons.
- Network:** Fields for SSID (H22_WIFI_AP) and Password (12345678) with "Get" and "Set" buttons.
- 4G Information:** Fields for APN ACC and 4G PIN, and APN User and Password.
- Server Information:** Fields for IP and Port with "Get" and "Set" buttons.
- Camera Config:** A large section with numerous settings including Resolution (1280x720 30f), Infrared (Manual), Quality (Normal), Coding Format (H.264), Split Time (15 Mns), Loop Record (OFF), Pre-Record (OFF), Live Stream (OFF), Resolution (848x480 30P), and many others, each with a "Get" or "Set" button.

G. Click “Enter U Disk” (in the upper right corner) to make the device to be recognized by PC as U Disk. All files can be checked in U Disk.

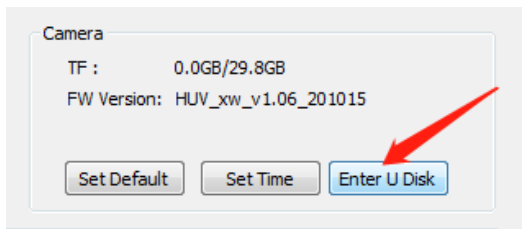

IMPORTANT INFORMATION

The clips and attachment studs rotate 360 degrees -

The crocodile clip, epaulette clip, chest harness and shoulder harness attachment studs ALL turn 360 degrees. Slot the clip into the back of the camera then turn the clip vertically. Or you can slot the clips into the back of the body camera first, then attach the body camera to the chest or shoulder harness, then turn the body camera vertically.

Reset device-

To reset the device, use a small needle to jab the reset button. The reset button is located next to the USB port.

Delete files -

You can delete the recorded files from a computer or through app. This is to stop people from getting rid of the evidence straight from the device itself.

Product warranty -

We offer a 12-month warranty on the body camera. This warranty covers faults that were caused by the manufacturer. If the fault was caused by the customer, then the warranty will be void.

USB cable -

Please only use the USB cable provided in the product box. Using other USB cables might cause damage to the body camera.

Attention -

- ① Charge camera fully after camera is left without working for long time.
- ② Keep camera bottom away from water to avoid short circuit or oxidation.
- ③ Don't disassemble camera without authorized instruction.
- ④ When **WiFi is on** or **low battery**, external camera connection is disabled.
- ⑤ BodyCam PC software (Camera Manager) works on windows system computer only.

